







33 300 845 Produktversion ab 01.04.2024



- Brauseabgang 3/8"
- Schubrosetten Ø 60 mm
- Anschluss 1/2"
- Stichmaß 150 mm ± 15 mm

Eigensicher gegen Rückfließen.

	Schwarz matt	33 300 845-33
	Chrom	33 300 845-00
	Platin gebürstet	33 300 845-06
	Dark Chrome	33 300 845-19
	Light Gold gebürstet	33 300 845-27
	Chrom gebürstet	33 300 845-93
	Dark Platinum gebürstet	33 300 845-99

33 300 845 Produktversion ab 01.04.2024

mm [inches]

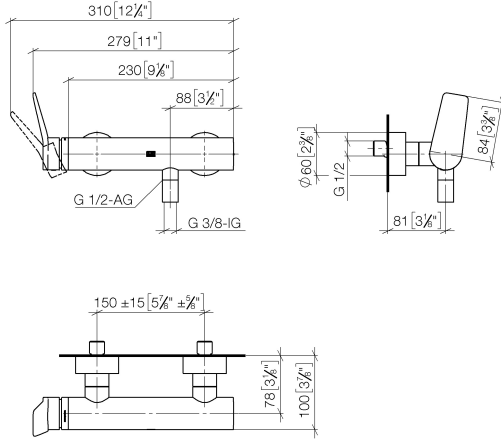

Durchflussdiagramm

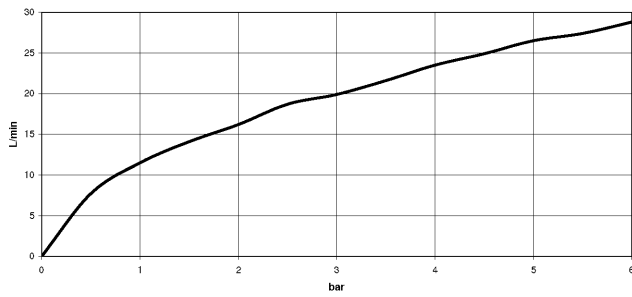

Codes & Standards

DIN 4109

ISO 3822

Scottish Water
Byelaws

UK Water Supply
Regulations

Ü-Zeichen



LISSÉ Brause-Einhandbatterie für Wandmontage - Schwarz matt

LISSÉ

33 300 845 Produktversion ab 01.04.2024

Zertifikate

LGA_9

WRAS_2207

33 300 845 Produktversion ab 01.04.2024

Ersatzteile für die
anderen
Oberflächenvarianten
finden Sie hier:
Chrom

