













20 000 808 Produktversion ab 13.03.2017



- Bohrungsdurchmesser 32 mm
- Rosette Ø 60 mm
- mit Warmkennzeichnung

	Dark Platinum gebürstet	20 000 808-99
	Chrom	20 000 808-00
	Platin gebürstet	20 000 808-06
	Platin	20 000 808-08
	Dark Brass matt	20 000 808-16
	Dark Bronze matt	20 000 808-17
	Dark Chrome	20 000 808-19
	Light Gold gebürstet	20 000 808-27
	Messing gebürstet (23kt Gold)	20 000 808-28
	Bronze gebürstet	20 000 808-42
	Champagne gebürstet (22kt Gold)	20 000 808-46
	Champagne (22kt Gold)	20 000 808-47

20 000 808 Produktversion ab 13.03.2017

mm [inches]

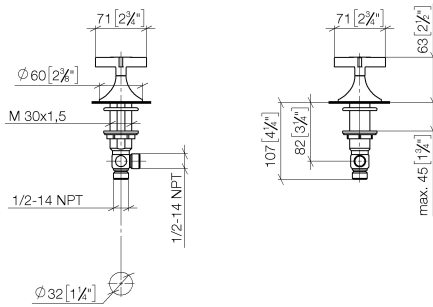

Durchflussdiagramm

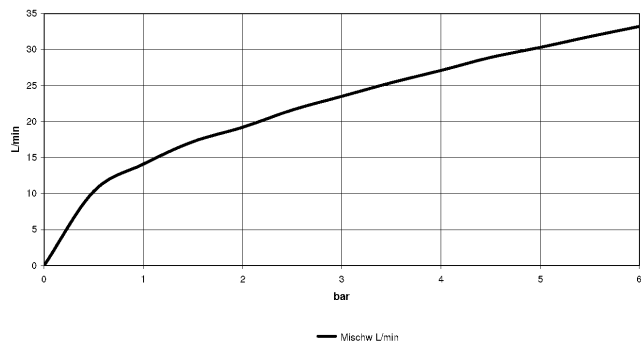

Codes & Standards

ASME A112.18.1	cUPC	DIN 4109	ISO 3822
Scottish Water Byelaws	UK Water Supply Regulations	Ü-Zeichen	



VAIA Seitenventil , rechtsschließend , warm - Dark Platinum gebürstet

VAIA

20 000 808 Produktversion ab 13.03.2017

Zertifikate

WRAS_2310

LGA_29

IAPMO_4976

20 000 808 Produktversion ab 13.03.2017

Ersatzteile für die
anderen
Oberflächenvarianten
finden Sie hier:
Chrom

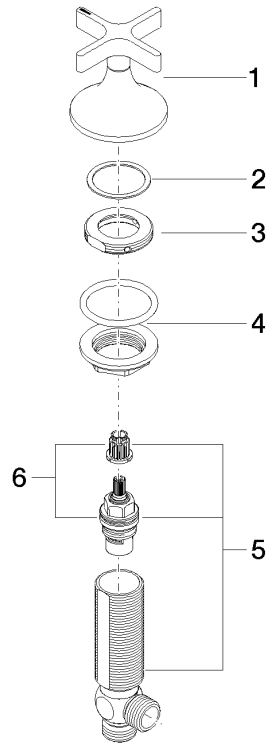

Ersatzteilstückliste

Nr.	Artikelnummer	Benennung	Verbaumenge	Lieferzeit
1	90 20 80 011 00-99	Griff für Seitenventil Hot Ø 71 x 63 mm - Dark Platinum gebürstet	1,00	20
2	09 28 10 003 90	Dichtung 39 x 32,5 x1 mm -	1,00	2
4	04 23 10 032 46 90	Befestigung mit Dichtungen M30 x 1,5 -	1,00	2
6	90 90 03 131 00 90	Oberteil , rechtsschließend 1/2" -	1,00	2
5	04 17 11 055 31 90	Seitenventil , rechtsschließend 1/2" -	1,00	2
3	09 24 01 028 90	Ring Ø 42 x 9 mm -	1,00	2